



TORNADO INDUSTRIES, LLC
3101 WICHITA COURT
FORT WORTH, TX 76140
PHONE 800-VACUUMS
FAX 817-551-0719
WWW.TORNADOVAC.COM

**Operations & Maintenance Manual
For Commercial Use Only**



**MINI MARATHON 425
MODEL NO: 98150**

NOTES



PROTECT THE ENVIROMENT
Please dispose of packaging materials in an enviromentally safe way according to local waste disposal regulations.



Always remember to recycle.

Within 30 days, to activate the warranty, go to;
<https://tornadovac.com/services/warranty-registration-form.aspx>

For warranty information go to www.tornadovac.com

Congratulations on your purchase of a Self-Contained Carpet Extractor. You are now equipped to handle any and all commercial carpet cleaning jobs. Your new unit is a high quality, precision-made product. All parts used in the manufacturing of this unit have passed rigid quality control standards prior to assembly. Please safeguard the original receipt / invoice. If you experience any problems with your unit during the warranty period, the original receipt / invoice will act as proof of purchase.

IMPORTANT SAFETY INSTRUCTIONS

READ AND UNDERSTAND ALL INSTRUCTIONS BEFORE USING THIS UNIT

Read and understand this owner's manual and all labels on the unit before operating. Safety is a combination of common sense, staying alert and knowing how your unit works. Use this unit only as described in this manual. Use only manufacturer's recommended attachments. To reduce the risk of personal injury or damage to your unit use only recommended accessories.

WARNING To avoid fire, DO NOT use with a flammable or combustible liquid or floor cleaner.

WARNING To avoid electric shock, DO NOT expose to rain. Store Indoors.

To reduce risk of fire, electric shock, or injury:

- Do not use outdoors or on wet surfaces.
- Do not leave unit unattended when plugged in. Turn off the switch and unplug the electrical cord when not in use and before servicing.
- Do not allow to be used as a toy. Close attention is necessary when used near children.
- Use only as described in this manual. Use only manufacturer's recommended attachments.
- Do not use with damaged cord or plug. If unit is not working as it should, has been dropped, damaged, left outdoors, or dropped into water, return it to a service center before using.
- Do not pull or carry by cord, use cord as a handle, close a door on cord, or pull a cord around sharp edges or corners. Do not run the unit over cord. Keep cord away from heated surfaces.
- Do not use extension cords or outlets with inadequate current carrying capacity.
- Turn off all controls before unplugging.
- Do not handle plug or unit with wet hands.
- Do not put any objects into openings. Do not use with any opening blocked, keep free of dust, lint, hair, and anything that may reduce airflow.
- Keep hair, loose clothing, fingers, and all parts of body away from openings and moving parts.
- Do not pick up anything that is burning or smoking, such as cigarettes, matches or hot ashes.
- Use extra care when cleaning on stairs. Do not use to pick up flammable or combustible liquids such as gasoline, or use in areas where they may be present.
- Store your unit indoors in a cool, dry area.
- Do not unplug by pulling on cord. To unplug, grasp the plug, NOT THE CORD.
- Follow these guidelines to ensure operator safety and to maintain equipment in running order.
- Make sure the machine is plugged into an electrical outlet with the same voltage rating as shown on the nameplate of the machine.
- Do not attempt to plug a 115 volt machine into a 230 volt outlet or a 230 volt machine into a 115 outlet.
- Replace a damaged cord immediately.
- If an extension cord is necessary, use a three conductor grounding cord-12 gauge wire or heavier to prevent motor burnout and over-heating of wires
- Do not expose the machine to freezing temperatures.
- Do not use the machine for totally dry vacuuming. This machine is not fitted with a fine dust filter.

- Do not use citrus-based cleaners in this machine.
- Do not use cleaning chemicals in this machine except those recommended for commercial extraction equipment. The use of any chemical with abrasive additives voids the warranty.
- Do not break off or pull out the ground prong on the plug.
- Do not attempt repair on a warranted machine unless instructions to perform it by an authorized shop are obtained from the factory.
- Do not use any replacement parts except those specified on the parts list. Proper performance of the machine could be affected if substitutions are made.
- Use defoamer at all times to prevent damaging the vacuum motor.
- Do not use water in excess of 140° F (60° C).
- Failure to comply with the above warning instructions will void the warranty.

GROUNDING INSTRUCTIONS

This appliance must be grounded. If it should malfunction or breakdown, grounding provides a path of least resistance for electric current to reduce the risk electric shock. This machine is equipped with a cord having an equipment -grounding conductor and grounding plug. The plug must be inserted into an appropriate outlet that is properly installed and grounded in accordance with all local codes and ordinances.

WARNING: Improper connection of the equipment-grounding conductor can result in a risk of electric shock. Check with a qualified electrician or service person if you are in doubt as to whether the outlet is properly grounded. Do not modify the plug provided with the appliance - if it will not fit the outlet, have a proper outlet installed by a qualified electrician.

This appliance is for use on a nominal 115-volt circuit, and has a grounding plug that looks like the plug illustrated in sketch A.

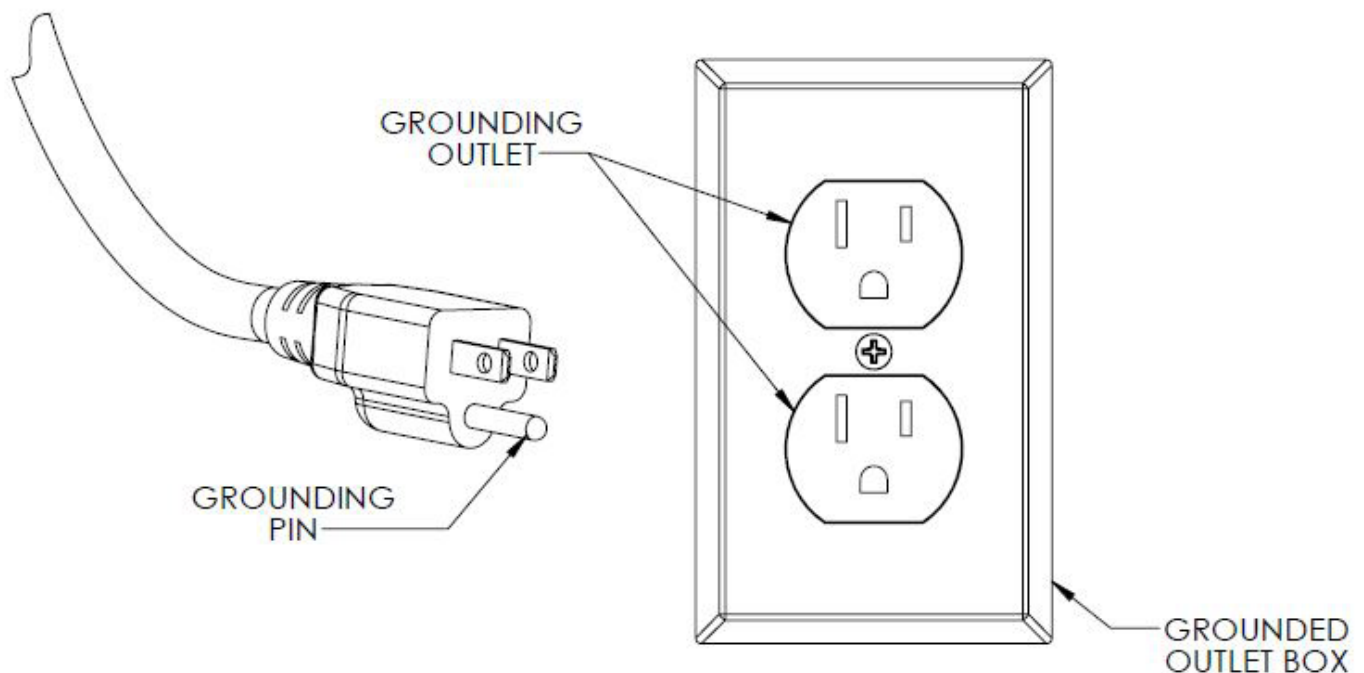

A

GENERAL INSTRUCTIONS

MACHINE COMPONENTS & SETUP

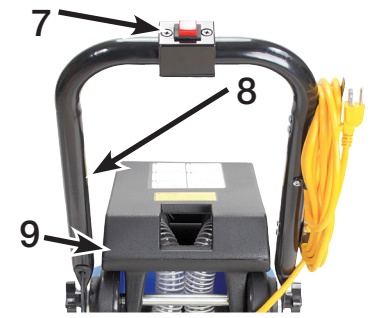
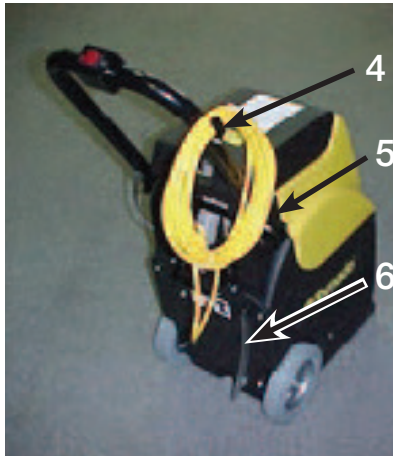
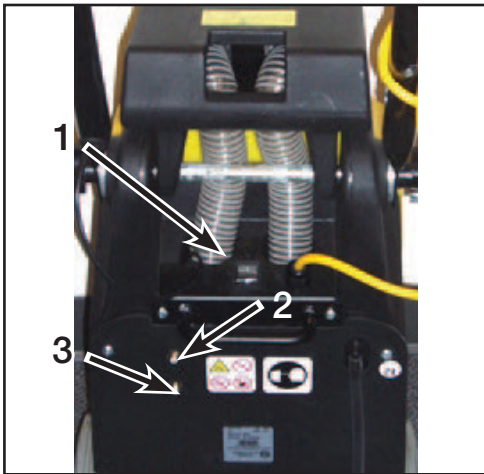

1) Main power ON/OFF switch	2) Pump reset button	3) Brush reset button
4) Power cord wrap	5) Folding handle lock knob	6) Solution tank drain hose knob
7) Solution switch	8) Folding handles	9) Recovery tank cover
10) Recovery tank	11) Solution tank	12) Accessory tool solution hose coupler
13) Accessory tool vacuum hose port	14) Recovery shoe	



Figure 1

1) Carefully check carton for signs of damage. Report damages at once to carrier. The machine is shipped fully assembled and is ready for use.

2) Adjust handle from transport position. To adjust, rotate handle knob to outward position and lift handle to desirable operating height, turn knob inward to lock handle (Figure 1).



Figure 2

3) Open cover and remove recovery tank from machine. Make sure the float shut-off screen and solution tank strainer are in place before use (Figure 2).

4) Using a clean bucket or hose, fill solution tank with 4 gal (15 L) of hot water, 140°F (60°C) maximum (Figure 3). Observe solution tank hose at rear of machine when filling. The hose indicates the amount of water in solution tank. (Figure 4) Do not use recovery tank to fill machine. Use a clean bucket.



Figure 3

5) Add a recommended Powr-Flite extraction cleaner, such as Powr-Extract 7 or Powr-Extract Plus.

6) Replace recovery tank and close cover after filling.

7) Plug machine's power cord into a grounded wall outlet.



Figure 4

ATTENTION: Do not use recovery tank to fill solution tank. Residual dirt or debris could cause damage to solution pump.

WARNING: Flammable materials can cause an explosion or fire. Do not use flammable materials in tank(s).

FOR SAFETY: When using machine, follow mixing and handling instructions on chemical containers.

FOR SAFETY: Do not operate machine unless cord is properly grounded. Do not operate machine with the use of an extension cord.

MACHINE COMPONENTS & SETUP

FOR SAFETY: Do not operate machine unless operator manual is read and understood.

PRE-OPERATION

- 1) Vacuum carpet and remove other debris.
- 2) Perform MACHINE SETUP procedures.
- 3) Inspect power cord for damage.

CLEANING CARPETS

- 1) Turn main power switch on (Figure 5).
- 2) To begin cleaning carpets, push solution switch on handle and slowly pull machine backwards (Figure 6).
- 3) Release solution switch at end of path and continue to pull machine to pick up excess solution.
- 4) Tip machine back on wheels and push machine forward to begin next path.

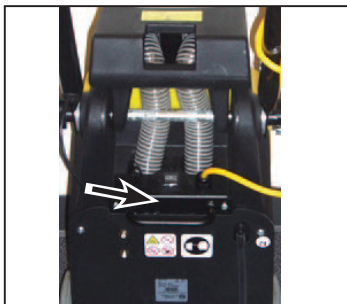

Figure 5

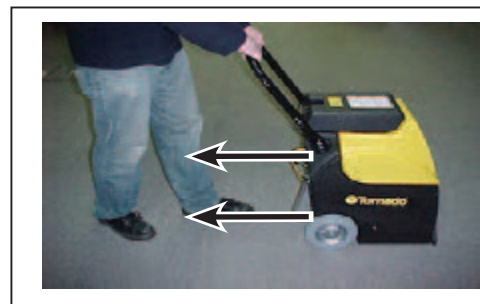

Figure 6

WHILE OPERATING

- 1) Overlap each path by 2 in (50 mm).
WARNING: Flammable materials or reactive metals can cause an explosion or fire. Do not pick up these types of materials.
- 2) Work away from outlet and power cord to prevent cord damage.
- 3) Periodically check for excessive foam buildup in recovery tank. Use defoamer foam control solution to prevent vacuum motor damage. **ATTENTION:** Excessive foam buildup will not activate the float shut-off screen.
- 4) If brush stops, the circuit breaker may have been tripped. Unplug power cord and check brush for obstruction. Push brush reset button on resume (Figure 7). Resume cleaning.
- 5) To clean heavily soiled areas, repeat cleaning path from different direction.
- 6) When float shut-off is activated or when recovery appears to stop, empty recovery tank (Figure 8).

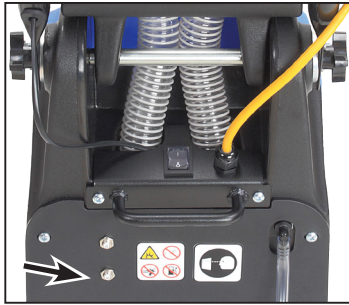

Figure 7



Figure 8

CLEANING WITH ACCESSORY TOOLS

- 1) Connect accessory tool hoses to solution hose coupler and vacuum hose port located at front of machine (Figure 9).
- 2) Turn main power switch on (Figure 10).
- 3) Operate accessory tools as normal. **NOTE:** When cleaning upholstery always check cleaning instructions sewn in furniture by manufacturer.
- 4) After cleaning, relieve water pressure from tool before disconnecting hose. Push switch for five seconds after turning main power switch off.

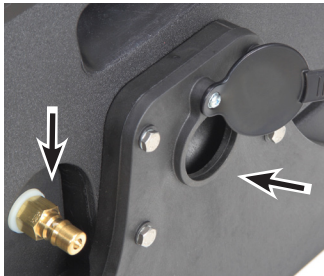

Figure 9

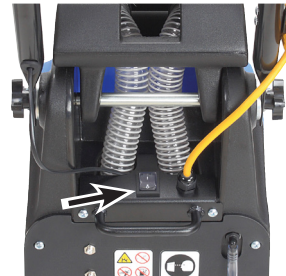

Figure 10

DRAINING TANKS

FOR SAFETY: When servicing machine, unplug cord from wall outlet.

DRAINING RECOVERY TANK

- 1) Turn machine off and unplug power cord.
- 2) Open cover; lift recovery tank out and empty (Figure 11). **NOTE:** Make sure to rinse out recovery tank after each use. Do not use this tank to fill machine with cleaning solution.



Figure 11

DRAINING SOLUTION TANK

- 1) Pull solution tank drain hose off of hose barb at rear of machine and empty remaining solution (Figure 12).
- 2) Replace drain hose.



Figure 12

STORING MACHINE

- 1) Before storing machine, be certain to empty and rinse both tanks of all solution.
- 2) Store machine in a dry area in the upright position.
- 3) Open recovery tank cover to promote air circulation.

ATTENTION: Do not expose to rain. Store indoors.

ATTENTION: Do not store in freezing temperatures of 32°F (0°C) or below.

DAILY (EVERY 4 HOURS OF OPERATION)

- 1) Empty and rinse out recovery tank thoroughly (Figure 13).
- 2) Remove float shut-off screen from recovery tank cover and clean (Figure 14).
- 3) Drain remaining water from solution tank (Figure 15).
- 4) Clean solution tank fill port strainer.
- 5) Remove any entangled carpet fibers and debris from brush (Figure 16).
- 6) Remove any debris lodged in pick up head.
- 7) Wipe off power cord and check for damage, replace if necessary. Coil cord neatly after use.
- 8) Clean machine with all purpose cleaner and damp cloth.

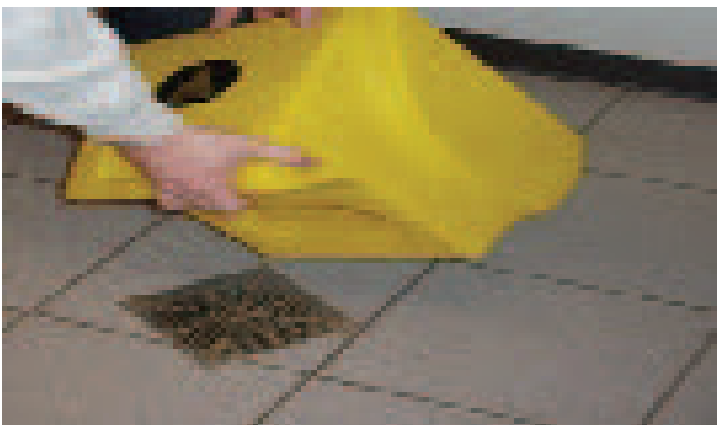

Figure 13

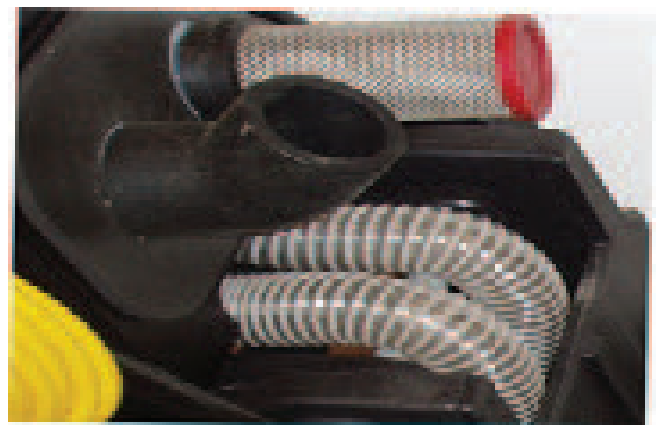

Figure 14



Figure 15



Figure 16

WEEKLY (EVERY 20 HOURS OF OPERATION)

- 1) Inspect vacuum hoses for holes and loose cuffs.
- 2) Inspect spray pattern for clogs. If clogged, remove spray tips by twisting spray tip body counter-clockwise and clean orifices.
- 3) Inspect cord and cord grip for damage. Replace immediately if damaged.

MONTHLY (EVERY 80 HOURS OF OPERATION)

- 1) Flush solution system with recommended liquid neutralizer to dissolve normal chemical buildup.
 - a. Pour 2 gal (7.5 L) of hot water 140°F (60°C) into solution tank. Add a liquid neutralizer according to mixing instructions on bottle. **FOR SAFETY:** When using machine, follow mixing and handling instructions on chemical containers.
 - b. Position brush over floor drain and operate machine for one minute.
 - c. Connect hand tool solution hose to machine and also over a floor drain operate tool for one minute.
 - d. Shut off machine and allow remaining solution to break down chemical buildup overnight.
 - e. Next day, spray out remaining solution and flush system with 3gal (11 L) of clean water.
- 2) Lubricate wheels with water resistant oil.
- 3) Inspect machine for water leaks and loose hardware.

QUARTERLY (EVERY 250 HOURS OF OPERATION)

- 1) Check vacuum motor for carbon brush wear. Replace brushes if worn to a length of 3/8 in (10 mm) or less.

FILTER MAINTENANCE

EXTERNAL FILTER

- 1) Remove the recovery tank and locate the filter (Figure 17).
- 2) Grasp the inner handles and pull out the filter.
- 3) Rinse the filter bag inside and out.
- 4) Replace the filter by snapping the filter back into place.

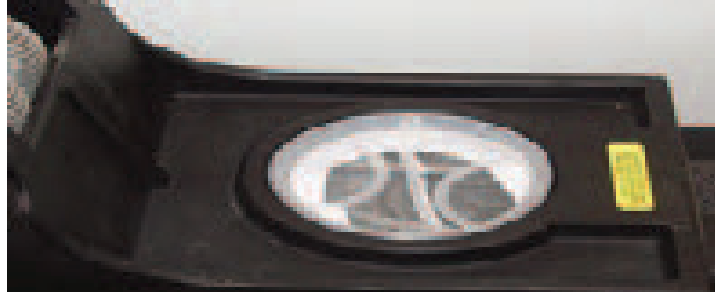

Figure 17

INTERNAL FILTER

- 1) Take off the back cover by removing the four screws.
- 2) Locate the filter next to the vacuum motor and unscrew the cap.
- 3) Remove the filter screen from the cap and rinse it thoroughly.
- 4) Reassemble the screen, cap, and fasten the back cover on.

MAINTENANCE GUIDE

Machine does not operate

CAUSE	SOLUTION
1) Faulty switches or wiring.	1) Contact manufacturer or service center.
2) Faulty power cord.	2) Contact manufacturer or service center.
3) Building circuit breaker tripped.	3) Reset circuit breaker according to operating instructions

Brush motor does not operate

CAUSE:	SOLUTION:
1) Brush motor circuit breaker tripped.	1) Let motor cool and reset brush motor breaker button at rear of machine
2) Switch not pushed.	2) Push solution switch.
3) Loose or broken brush belt.	3) Contact manufacturer or service center.
4) Faulty switch or wiring.	4) Contact manufacturer or service center.
5) Faulty brush motor.	5) Contact manufacturer or service center.

Solution pump does not operate

CAUSE:	SOLUTION:
1) Solution pump circuit breaker tripped.	1) Let pump cool and reset pump breaker button at rear or machine.
2) Switch not pushed.	2) Push solution switch.
3) Faulty switch or wiring.	3) Contact manufacturer or service center.
4) Faulty solution pump motor.	4) Contact manufacturer or service center.

Vacuum motor does not operate

CAUSE:	SOLUTION:
1) Loose or broken wiring.	1) Contact manufacturer or service center.
2) Faulty main power switch.	2) Contact manufacturer or service center.
3) Defective vacuum motor.	3) Contact manufacturer or service center.
4) Worn carbon brushes.	4) Contact manufacturer or service center.

Poor solution pick-up

CAUSE	SOLUTION
1) Defective recovery tank cover gasket.	1) Replace gasket.
2) Clogged float shut-off screen.	2) Open recovery tank cover and clean lint off screen.
3) Accessory tool vacuum hose port cover is loose or missing.	3) Check vacuum hose port cover.
4) Loose vacuum hose cuffs.	4) Secure connections under cover.
5) Pulling machine too fast.	5) Slow down cleaning process.

Uneven or no spray

CAUSE	SOLUTION
1) Clogged spray tips.	1) Clean or replace tips.
2) Improper spray tip size or spray angle.	2) Replace with proper tips.
3) Clogged solenoid valve.	3) Contact manufacturer or service center.
4) Worn spray tips.	4) Replace spray tips.
5) Solution tank low or empty.	5) Refill solution tank.
6) Faulty solution pump.	6) Contact manufacturer or service center.
7) Pump needs priming.	7) Prime pump by pressing solution hose coupler tip located at front of machine.

